

O H M

Live Your Dream

User Manual

Cordless Vacuum Cleaner

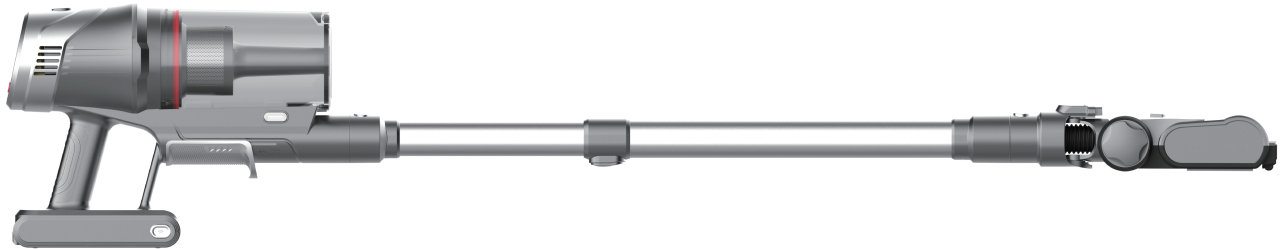

Lunar

WARRANTY

The 2-Year Limited Warranty

- Your OHM vacuum cleaner has a 2-year warranty against original defects in material and workmanship, when used for private household purposes in accordance with the Instruction Manual.
- This warranty provides, at no extra cost to you, all labour and parts necessary to ensure your vacuum cleaner is in proper operating condition during the warranty period.



According to the requirements outlined in this instruction manual, subject to the following conditions and exclusions. Only applies to purchases made from authorised retailers of OHM Group Limited. This warranty will only be valid if the machine is used in the country in which it was sold.

WHAT IS NOT COVERED?

OHM Group Limited shall not be liable for costs, damages or repairs incurred as a result of:

- Vacuum cleaner purchased from an unauthorised dealer.
- Careless operation or handling, misuse, abuse and/ or lack of maintenance or use not in accordance with the OHM vacuum cleaner Instruction Manual.
- The vacuum cleaner is used for commercial or rental purposes in addition to normal domestic use.
- Use of parts not in accordance with the OHM vacuum cleaner Instruction Manual.
- Use of parts and accessories other than those produced or recommended by OHM Group Limited.
- External factors unrelated to product quality and use, like accidental water damage.
- Repairs or alterations carried out by unauthorised parties or agents.
- Normal wear and tear, including Dust Cup, Belt, Filter, HEPA filter, Brush roller, and Power Cord (or where external damage or abuse is diagnosed), carpet or floor damage due to use not in accordance with manufacturer's instructions or failure to turn the brush roller off when necessary.
- Reduction in battery discharge time due to battery age or use.

HOW TO CLAIM?

Please keep your proof of purchase. To make a claim under our Limited Warranty, you need to provide your original purchase receipt with the purchase date and order number on it.

All work will be carried out by OHM Group Limited or its authorised agency.

Any replaced defective parts will become the property of OHM Group Limited.

Service under this warranty will not extend the period of this warranty.

If your vacuum cleaner is not functioning properly, or you still have any questions after reading this manual carefully, please feel free to contact us, we will try our best to provide you with a satisfactory solution.

IMPORTANT SAFETY WARNING



Before using this vacuum cleaner, please read all instructions in the manual and cautionary markings on the machine carefully.





- ① This OHM vacuum cleaner is not intended for use by persons (including children) with reduced physical, sensory or reasoning capabilities, or lack of experience and knowledge, unless they have been given supervision or instruction concerning use of the machine by a person responsible for their safety.
- ② Use only as described in this OHM vacuum cleaner Operating Manual. If the vacuum cleaner is not working as it should, if it has received a sharp blow, if it has been dropped, damaged, left outdoors, or dropped into water, do not use and contact the OHM Group Limited Support Team.
- ③ Suitable for dry locations only. Do not install, charge or use this vacuum cleaner outdoors, in a bathroom or within 10 feet (3 meters) of a pool. Do not use on wet surfaces and do not expose to moisture, rain or snow.
- ④ When using this vacuum cleaner, please keep hair, loose clothing, fingers, and all parts of the body away from openings and moving parts. Do not point the hose, aluminium alloy tube or other accessories at your eyes or ears or put them in your mouth.
- ⑤ Do not use to pick up hard objects, such as glass slag, needles, nails, etc.
- ⑥ Do not touch the charger with wet hands to avoid electric shock.
- ⑦ Use only OHM Group Limited recommended accessories and replacement parts.
- ⑧ Do not water or spill liquid onto the vacuum cleaner. If that happens, it will increase the risk of electric shock.
- ⑨ Please do not use the vacuum cleaner to suck the detergent, kerosene, soot, wet dust, water, sewage, matches and other risky items.
- ⑩ Do not throw the battery pack away, and it should be safely disposed in accordance with local regulations.
- ⑪ Do not use a battery pack or vacuum cleaner that is damaged or modified. Damaged or modified batteries may exhibit unpredictable behaviour resulting in fire, explosion or risk of injury.
- ⑫ The charger has been designed for a specific voltage. Always check that the mains voltage is the same as that stated on the rating plate.
- ⑬ Unplug the charger when not in use for extended periods.
- ⑭ Please fully recharge the battery, when first used or used after a long time of storage. If the product is not used for a long time, please make sure the battery is recharged and used every three months at least.
- ⑮ Follow all charging instructions and do not charge the battery pack or the vacuum cleaner outside of the temperature range specified in the instructions. Charging improperly or at a temperature outside of the specified range may damage the battery and increase the risk of fire. To ensure maximum battery life, OHM Group Limited recommends the following:
 - When not in use the vacuum cleaner should be stored at room temperature. Recommended range: 18°C (64°F) to 28°C (82°F).
 - The ambient temperature range for operation and charging should be 8°C (50°F) to 35°C (86°F).
- ⑯ Please store the product in a cool and dry environment. Please avoid prolonged exposure of sunshine on the product.

CONTENTS

WHAT IS IN THE BOX.....	1
INTRODUCTION TO MAIN BODY	2
DISPLAY SCREEN INTRODUCTION	3
ASSEMBLY COMBINATIONS	4
SELF-STANDING METHOD	5
WALL MOUNTING	6
CHARGING METHODS	7
INSTRUCTIONS FOR USE	9
MAINTENANCE	11
REAR FILTER COMPONENT CLEANING	14
FLOOR BRUSH CLEANING	15
TROUBLESHOOTING	16

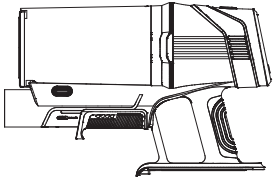
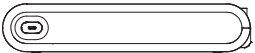
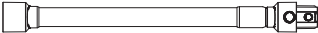
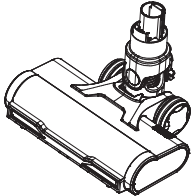
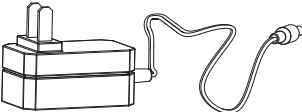
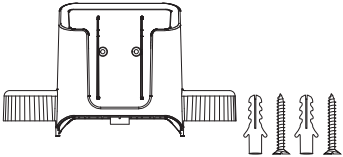
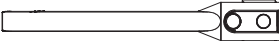
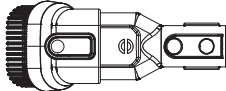
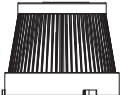
For support please contact our customer service team at:
customercare@myOHM.co.uk

WHAT IS IN THE BOX

			
Main Body	Battery Pack	Telescopic Rod	Floor Brush
			
Power Adapter	Wall Hanging & Hardware Bag	Long Crevice Nozzle	2-in-1 Brush
			
HEPA Filter	Aroma Insert	Goose Head Cleaning Brush	User Manual

INTRODUCTION TO MAIN BODY

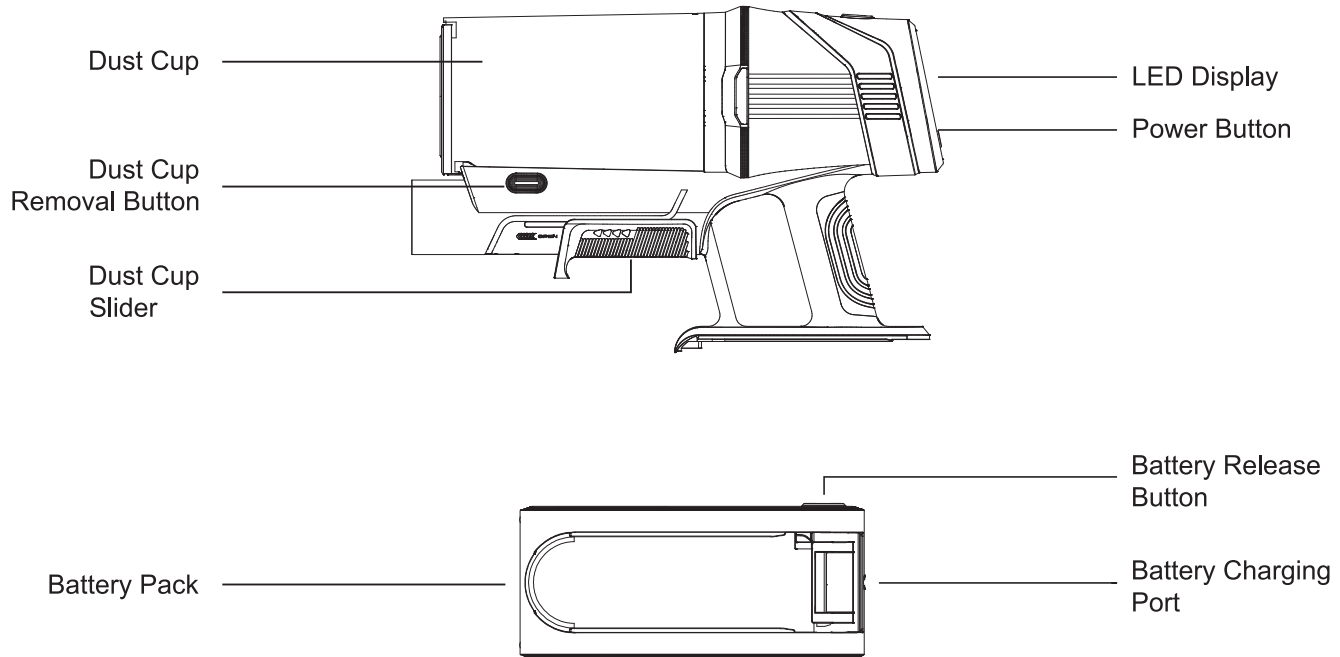

DISPLAY SCREEN INTRODUCTION

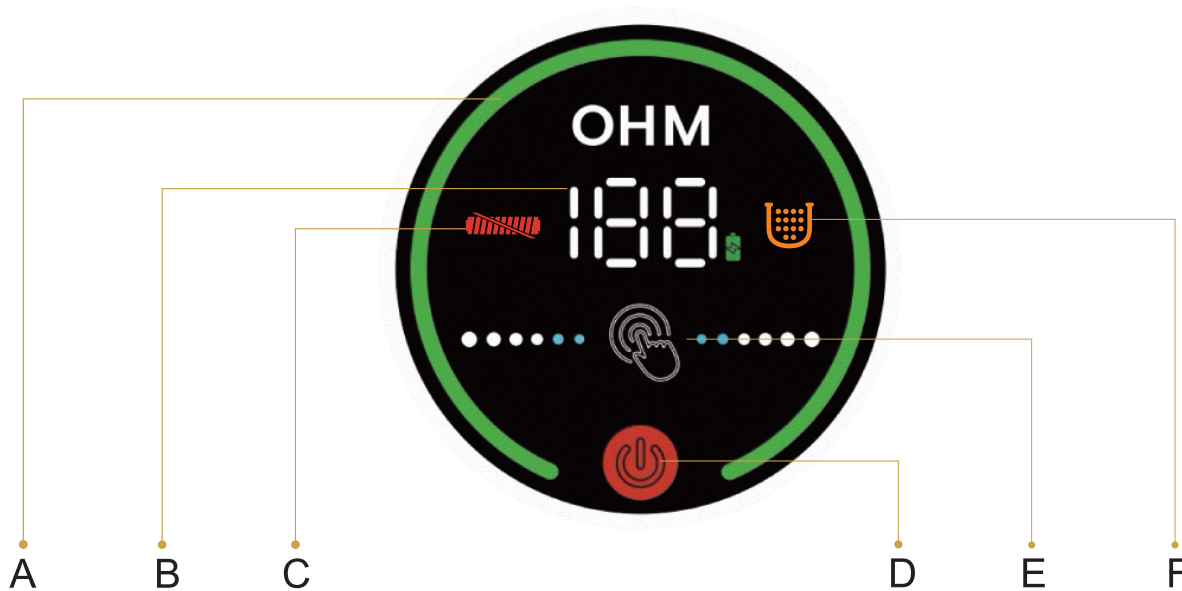

A.Power indicator light

B.Remaining battery power

C.Floor brush blocked indicator

D.Power button

E.Suction mode indicator (Eco/Standard/Turbo)

F.Dust Cup full indicator

ASSEMBLY COMBINATIONS

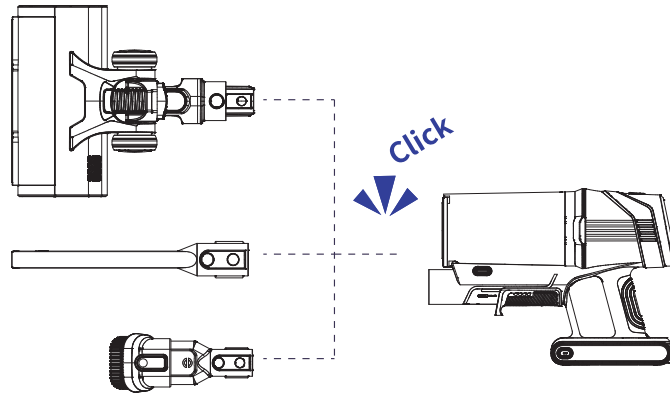
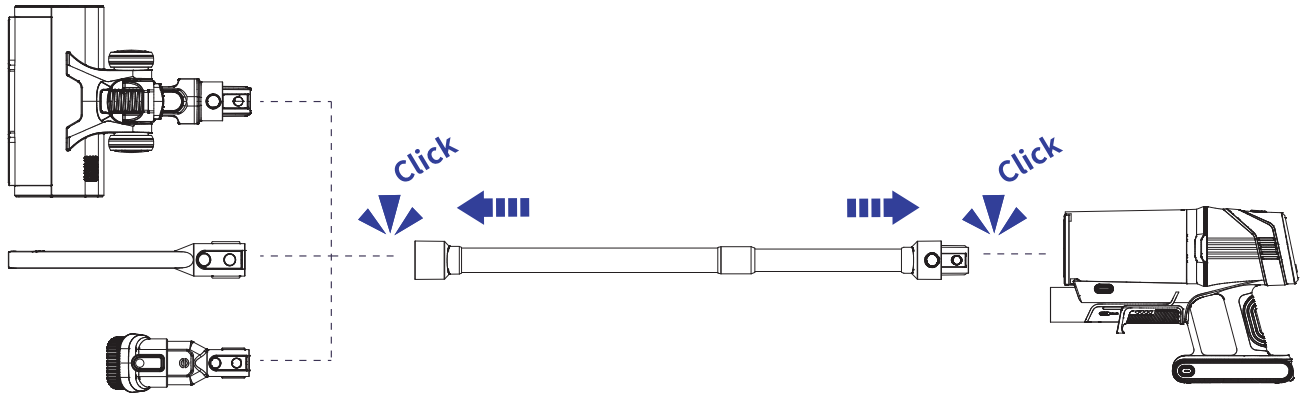

SELF-STANDING METHOD

Floor brush lock: Hold the handle, keep the floor brush still, gently push the main unit forward and the floor brush locks into place.

Cancel locking: Step on the side of the brush with your foot and gently pull the main unit back to unlock.

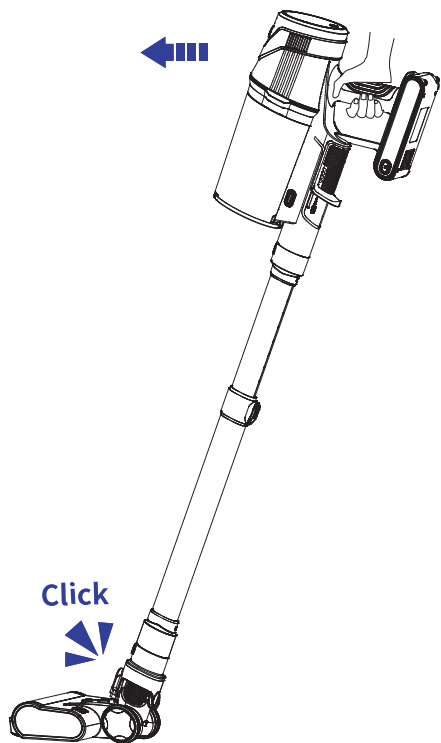

1 Floor brush lock

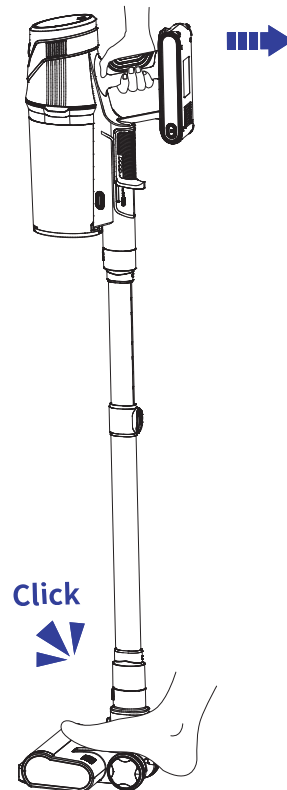

2 Cancel locking

WALL MOUNTING



Please make sure there is no gas, water or electrical pipes, cables or wires where you are wall mounting.

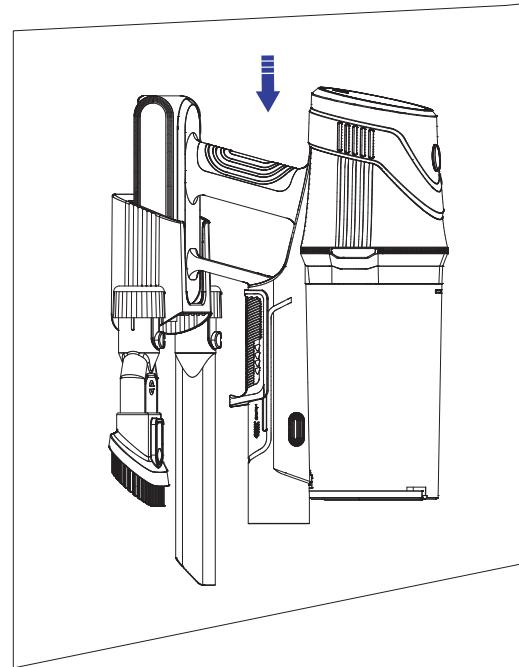
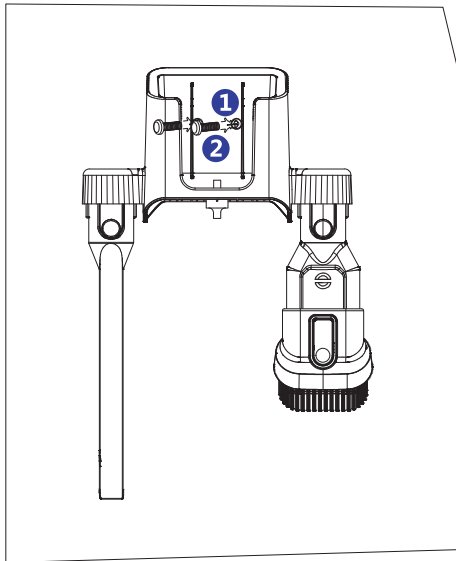

CHARGING METHODS



1. Please use OHM vacuum cleaner adapter to charge the product.
2. For first time use, it is recommended to fully charge the product before use.
3. Please charge it in time after each use. It is not recommended to completely drain the battery before charging.

Battery pack installation and removal

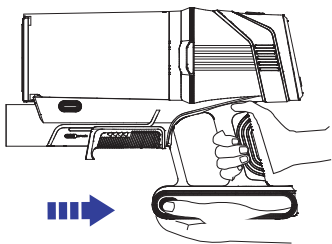

- 1 Remove the Battery Pack and Charge it Separately

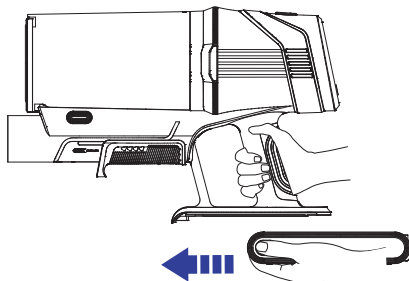
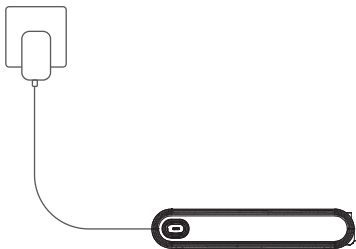

- 2 Connect the Main Body to Charge

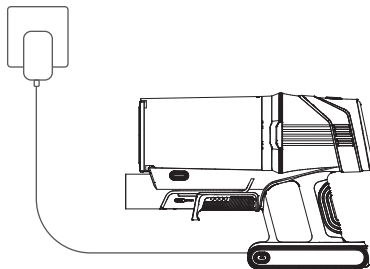

- 3 Hang on the Wall Mount to Charge

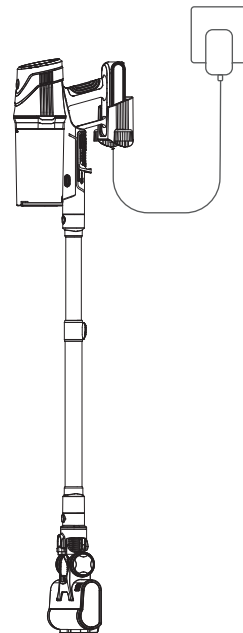

CHARGING METHODS

Charging Indicator



- When charging, the power dashboard on the display changes as the battery level changes.
- When fully charged, the display stays on for 1h and then goes off completely.

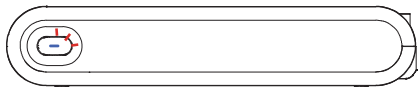

The battery indicator will flash in blue while charging, and the blue colour will stay on when the battery is fully charged.

Using wrong adapter

When using a non-OHM vacuum cleaner adapter, the battery pack blue light will flash rapidly.

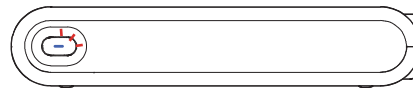

INSTRUCTIONS FOR USE

Start up

1. Press the power button to start.

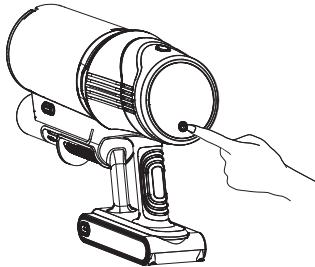

2. Real-time display of remaining power and suction mode status.



3. Low battery light display

When the battery level falls below 20%, the power dashboard on the display will begin to flash. The vacuum cleaner should be charged as soon as possible.

The remaining power is for reference only. There may be a certain deviation from the actual time in different modes and environments.

Suction mode adjustment

1. Press to change the suction mode.



2. Suction mode adjustment light display.

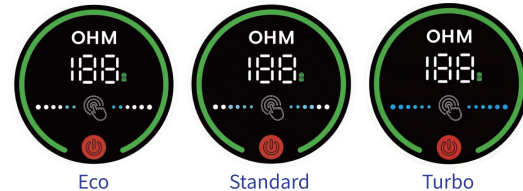

INSTRUCTIONS FOR USE

Shut down

1. Press the power button when the vacuum cleaner is on, to turn it off.

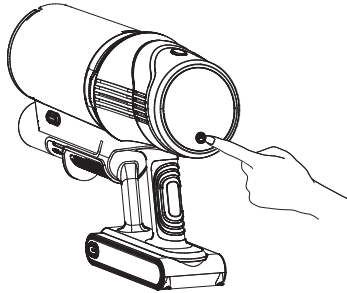

2. When the battery level falls below 20% at the end of the vacuum cleaner's run, the display provides a low battery reminder, which flashes for 10 seconds and then turns off.



Fault light display - Dust Cup full indicator

When the Dust Cup full indicator lights up, it means the product is blocked. Please remove the main body, floor brush, and tube for cleaning and inspection.



Fault light display - Floor brush blocked indicator

When the floor brush blocked indicator lights up, it means that the floor brush roller is stuck. Please pick up the floor brush, remove the roller, clean and check.

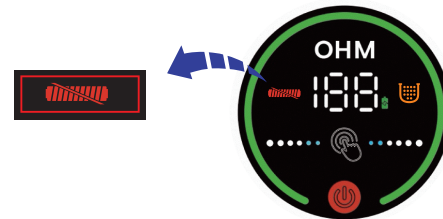

MAINTENANCE

Clean the main body

Please use a soft dry cloth to wipe the main unit, do not wash it with water.

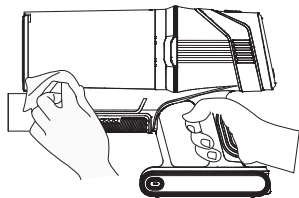

Dust cup maintenance

If used for a long time, it is recommended to clean and maintain once a month.

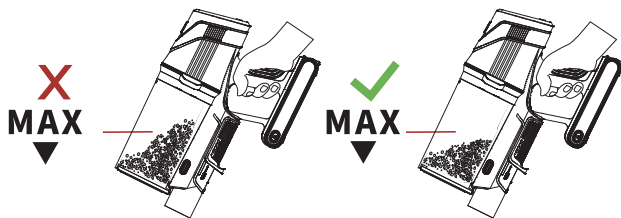

Dust cup is full

- 1 Use the Dust Cup Slider to empty the dust cup

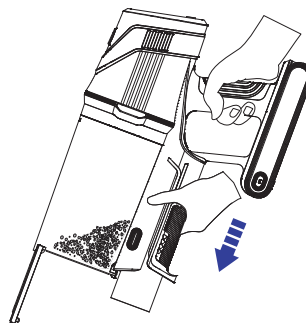

- 2 Dust cup removal

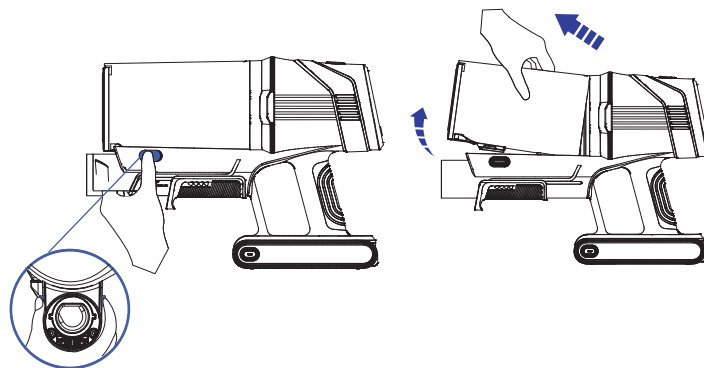

MAINTENANCE

Inlet HEPA filter maintenance

It is not recommended to wash the HEPA filter. Just use a cleaning brush to clean it regularly. If used for a long time, it is recommended to clean the HEPA filter every 2 weeks and replace it every 2 months to ensure long-term good suction.

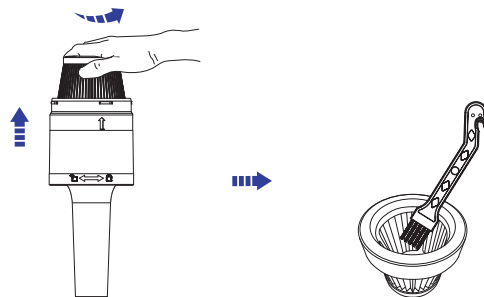
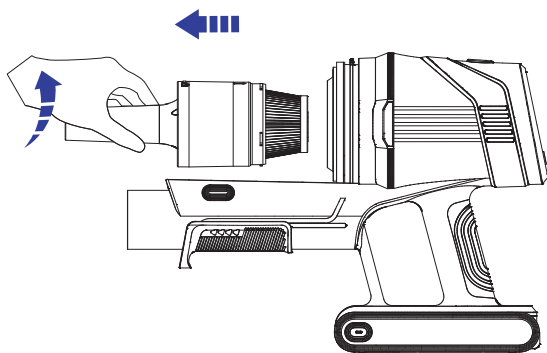

Inlet HEPA filter removal and cleaning

Cyclone filter maintenance

If used for a long time, it is recommended to clean and maintain once a month.

- 1 Disassembly complete

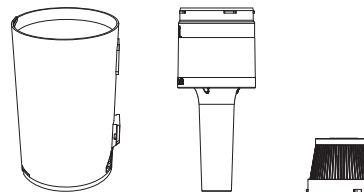

MAINTENANCE

2 Cyclone filter cleaning

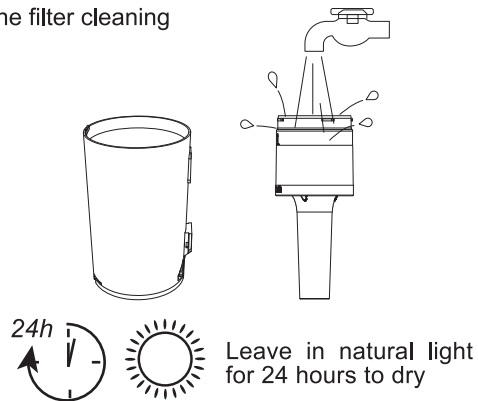

Filter component installation

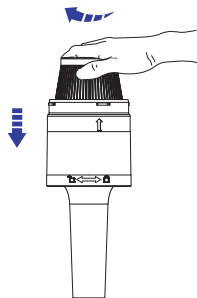

Dust cup filter assembly installation

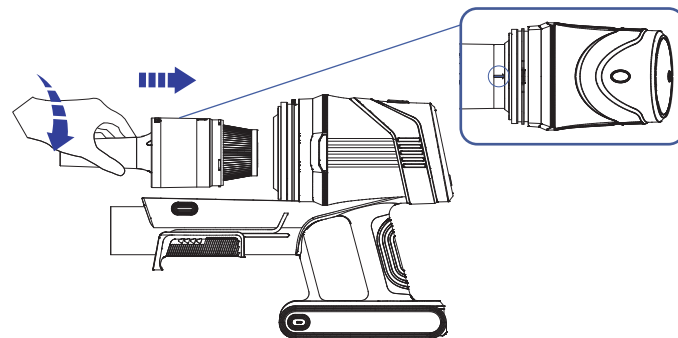

Dust cup installation

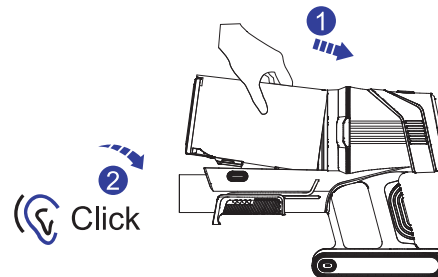

REAR FILTER COMPONENT CLEANING

Rear filter component cleaning

If used for a long time, it is recommended to clean it every six months and replace it every year.

1. Removing the air outlet cover

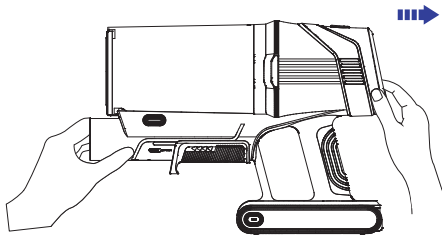

2. Outlet HEPA filter cleaning

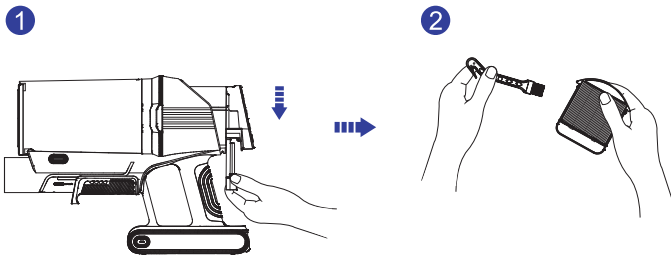

3. Put in aroma insert

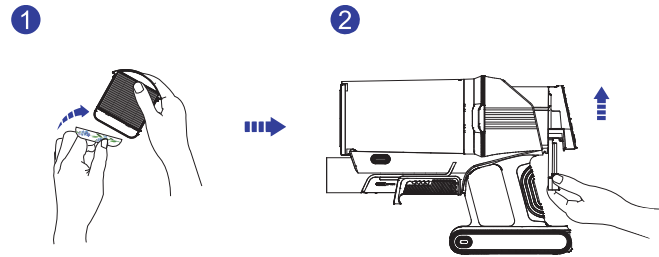

4. Installation of air outlet cover

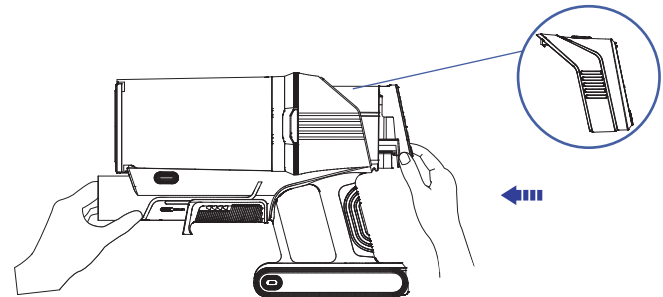

FLOOR BRUSH CLEANING

Floor brush cleaning

- 1. Before cleaning the floor brush, be sure to remove the floor brush from the main unit and disconnect the power supply.
- 2. Please use a soft dry cloth to wipe the main body, do not wash it with water.

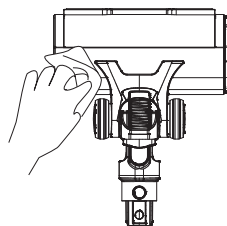

1. Clean floor brush

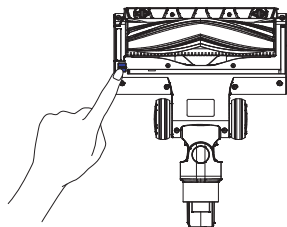

2. Open the buckle

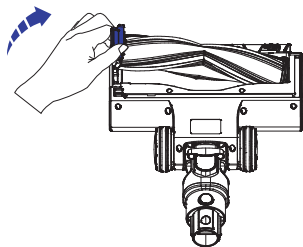

3. Take out the roller

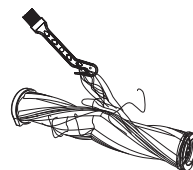

4. Clean any trapped debris

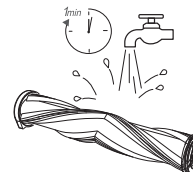

5. Wash roller

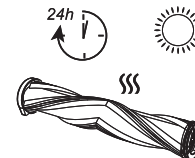

6. Dry in natural light for 24 hours

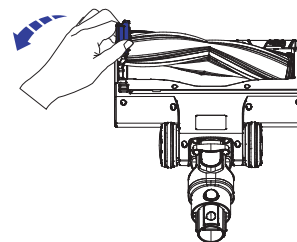

7. Re-install roller and close the buckle

TROUBLESHOOTING

Specification

Product	Cordless Vacuum Cleaner	Model	Lunar
Rated Voltage	29.6V ---	Cleaning Modes	Eco/Standard/Turbo

Troubleshooting

ISSUE	CAUSE	SOLUTION
Unable to start	<ol style="list-style-type: none"> 1. The battery is dead. 2. The battery pack is not installed or not installed in place. 3. Other reasons. 	<ol style="list-style-type: none"> 1. Please use OHM vacuum cleaner power adapter to charge the battery. 2. Please check whether the battery is connected to the product and re-install it to confirm that it is installed in place. 3. Please contact our customer support team.
Weak suction	<ol style="list-style-type: none"> 1. The dust cup is full. 2. Metal filters and HEPA filters are clogged. 3. The telescopic rod is blocked. 4. The electric floor brush is clogged. 5. Low battery power. Insufficient battery power will affect high power output to a certain extent. 6. Incorrect mode selection. 7. Other reasons. 	<ol style="list-style-type: none"> 1. Please empty the dust cup. 2. Please take out the metal filter and HEPA filters and clean it according to the prompts. 3. Please remove the telescopic rod and check whether the tube is blocked by foreign matter. 4. Please remove the floor brush roller and clean it, and check whether the floor brush pipe is blocked by foreign matter. 5. Please use OHM vacuum cleaner power adapter to charge the battery. 6. For complex environments, please switch to medium and high power mode to try cleaning. 7. Please contact our customer support team.
Short battery life	<ol style="list-style-type: none"> 1. The battery is not fully charged. 2. Frequent Turbo mode operation. 3. The ambient temperature is too low. Running the battery at low temperature will shorten the discharge time. 4. Other reasons. 	<ol style="list-style-type: none"> 1. Please use OHM vacuum cleaner power adapter to charge the battery. 2. In non-complex environments, please avoid working in Turbo mode for long periods of time. 3. Please contact our customer support team.



